



PD-1

Loddonside, Lands End House, Beggars Hill Road,
Charvil, Berkshire, RG10 0UD, UK
<http://www.colinbroad.com>
Tel +44 (0) 1189 320345 Fax +44 (0) 1189 320346

Pec - Direct Remote For DAW's (Revision 2 Software)

The PD-1 is a new approach to DAW monitoring. Film pioneered multi-channel recording, some current mixes can have over 200 separate elements in any section. The combination of multiple multi-channel segments with multi-format delivery requirements has forced film dubbing mixers to develop a flexible way of working which demands an appropriate monitoring system. Two main elements have evolved: firstly the concept of stems, premixed multi-channel elements, typically music, dialogue and effects, secondly the 'PEC-Direct' panel (PEC = Photo Electric Cell). This could also be called a 'tape-direct', "playback-direct" or today 'disk-direct', we prefer the original name 'Pec-Direct'.

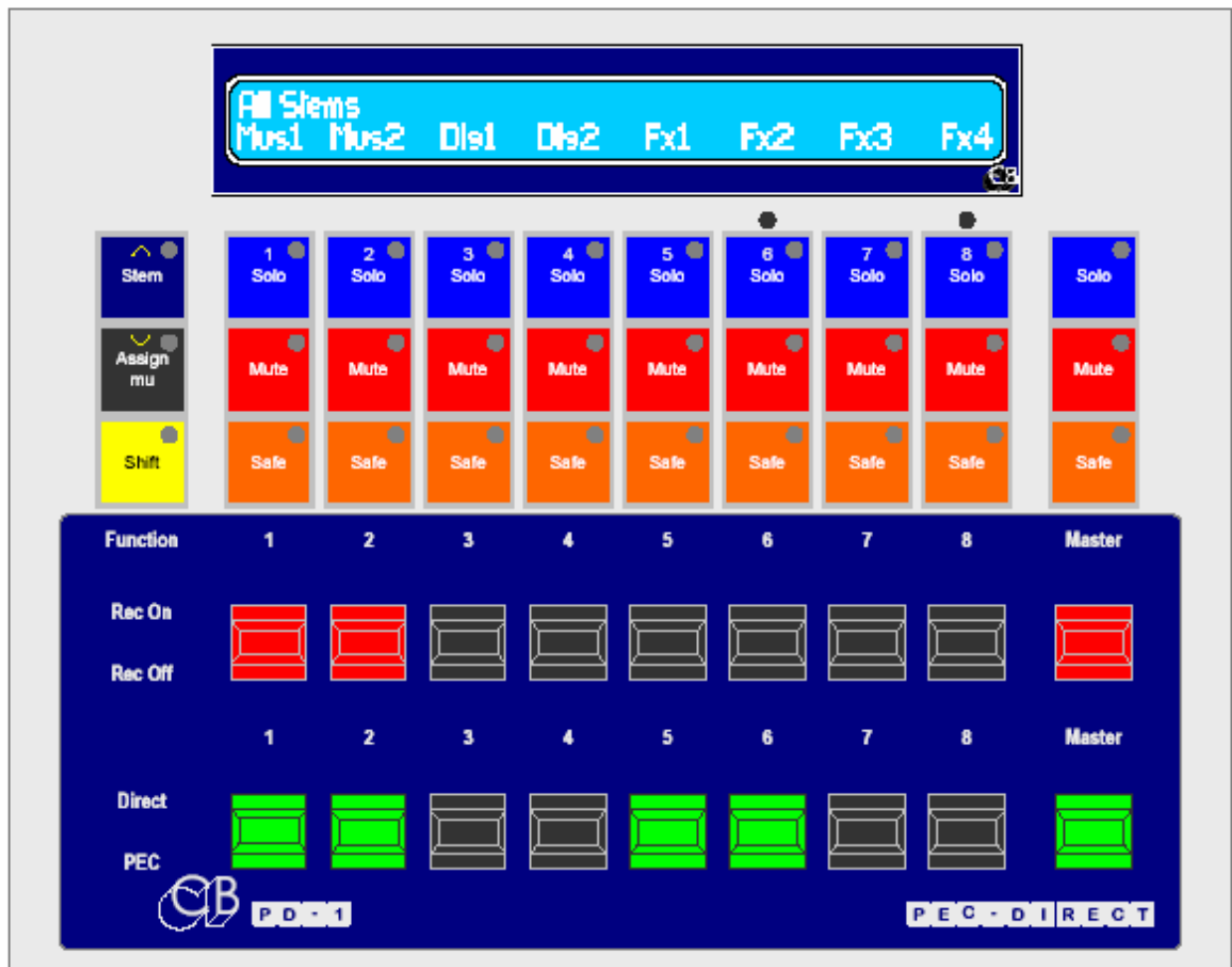

The typical monitor section in a film desk is a completely separate mixer with for example 6 stems of 8 tracks requiring 48 'Direct' inputs and 48 'Pec' inputs. The inputs are routed to up to 8 outputs (For example a 7 track mix of L, R, C, Sub/FX, LS, RS, CS). The dialogue stems may only be mono, the music stems may be two or three track or four track, and up to 7 track effect stems.

The PD-1 provides a new way to implement the 'Pec-Direct' panel concept. The solo, mute and source/playback switching are implemented within the digital audio workstation. By switching within the workstation a large number of interconnections and hardware are eliminated, for instance an outboard 48 track Pec/Direct unit would require 96 inputs!. The audio is then mixed within the workstation to generate the individual monitor feeds (LCRS...).

An added advantage of connecting directly to the DAW is that the Stem and Track names may be read directly from the DAW, stems may be generated automatically from the track names so that the user does not have to re-enter them.



Size: 7.6" x 8.7"

New in Revision 2 Software

- 1) **64 Tracks on Protools:** The PD-1 now supports up to 64 tracks on Pro-tools, version 1 supported 48 tracks maximum on Protools. (Both version 1 and 2 support 64 tracks on Pyramix). Note 64 tracks will only work when connected directly to protools/pyramix and not via the RM6.
- 2) **Print Master:** Any combination of stems/tracks may be specified as 'Print Master' Tracks. These will switch to record/input when any other tracks switch to record/input and will switch out of record or to playback when **all** other tracks switch out of record or to playback.

Table of Contents

New in Revision 2 Software	2
Table of Contents	3
Block Diagrams	5
Two Operator Multi-Master System with three master DAW's, two machines, and CBServer	5
Three User ProTools Icon System.....	6
Single User ProTools Icon System, Combined Record and Playback, Internal Video	7
Single User ProTools Icon System, Combined Record and Playback, Separate Video	7
Single User ProTools Icon System, Separate Record, Playback and Video.....	7
Pyramix Single Machine System: Internal Video	8
Pyramix Single Machine System: External Video.....	8
Pec - Direct Panel Operation	9
Solo In Place	9
Display	9
Stem	9
Global Group.....	9
Full Track Name.....	9
Stem Name	9
Keys.....	9
STEM.....	9
ASSIGN	10
Shift	10
Channel SOLO	10
Channel MUTE.....	10
Channel SAFE	10
Channel record Paddle.....	11
Channel PEC-Direct Paddle	11
Master MUTE	11
Master SOLO	11
Master Safe.....	11
Master record Paddle	11
Master PEC-Direct Paddle.....	11
Solo-Safe	11
UNIT SETUP.....	11
Root Menu.....	12
Track/Stem Assign	12
Start from Track Number.....	12
Number of Tracks.....	12
Shift held Function	13
Install Template.....	13
Stem & Track display	13
Stem & Track Name Format.....	13

Number of Global Groups.....	14
Number of Stems	14
User Group Contents.....	14
After Auto Stem.....	15
Panel Type.....	15
Test Display/Factory Setup.....	15
Port B Menu	16
Stem and Track Name Request.....	16
Position	16
Maximum Tracks per Command.....	16
Track Arm Commands	16
Protocol.....	16
Reading Stem and Track Names.....	16
Auto-Stem	17
Rear Panel Connections.....	17
Serial In.....	17
Serial Out.....	17
+5v.....	17
Software Updates.....	17
Appendix	18
Using the PD-1 with a Pro Tools.....	18
Pro Tools set-up : Single Pro Tools.....	18
Pro Tools set-up: Separate Record Pro Tools	18
Suggested ProTools Signal Path.....	19
Using the PD-1 with Pyramix	20
PD-1 Master/Slave Setting	20
Using the PD-1 with the UR-422	20
Using the PD-1 with the SR-4 or RM-6	20
SR-4, PD-1 Connections	20
RM-6, PD-1 Connections.....	20

Block Diagrams

Two Operator Multi-Master System with three master DAW's, two machines, and CBServer

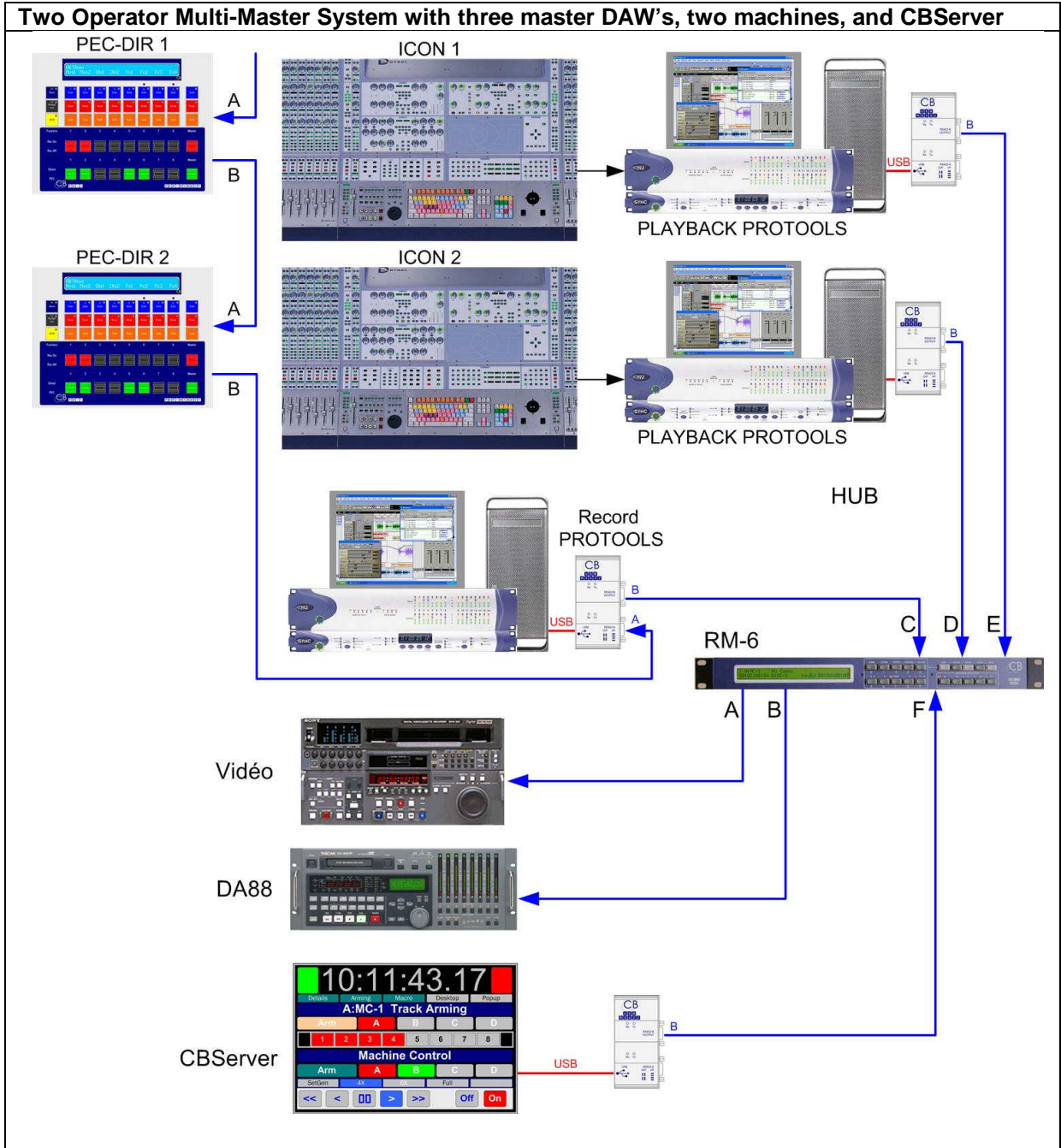

The Multi-Master Configuration allows the PD-1 to be used with any synchronizer that supports Multi-Master Operation.

Three User ProTools Icon System

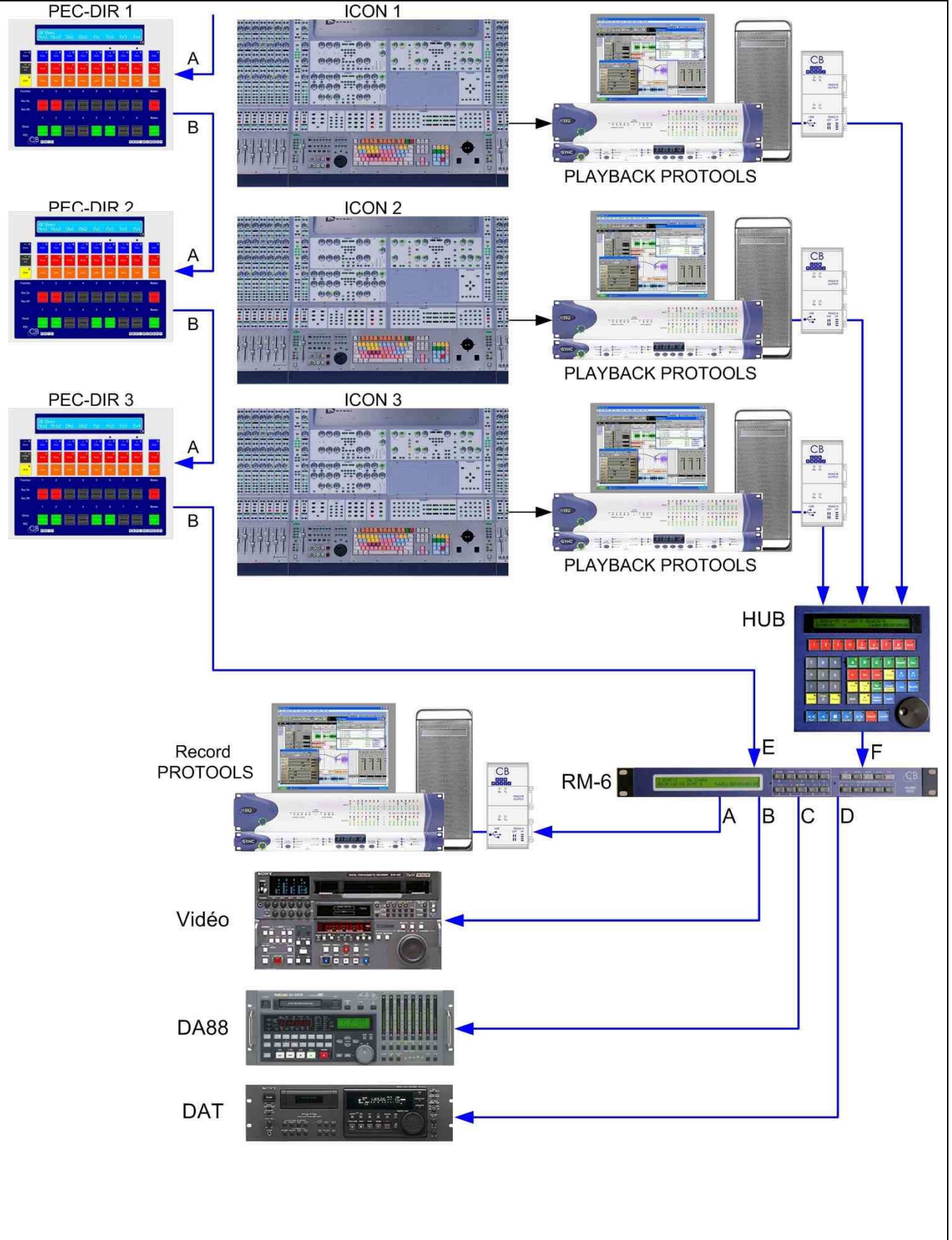

Single User ProTools Icon System, Combined Record and Playback, Internal Video



Single User ProTools Icon System, Combined Record and Playback, Separate Video

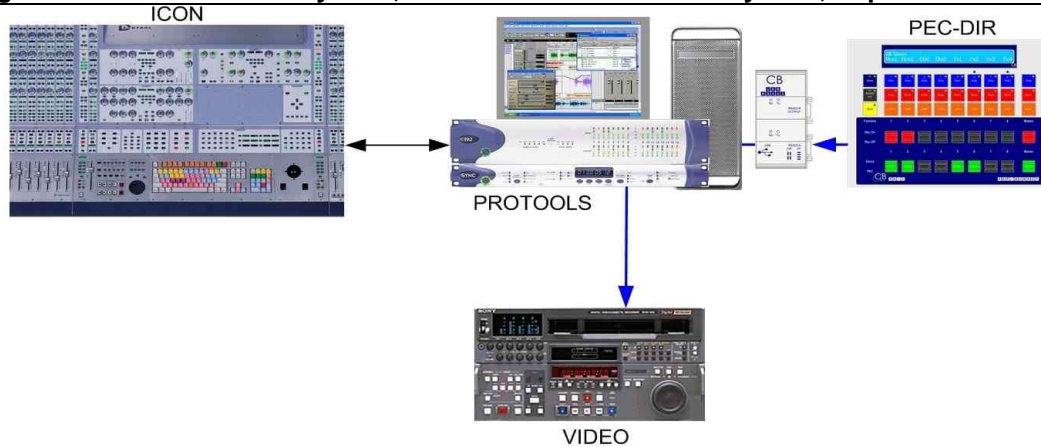

Single User ProTools Icon System, Separate Record, Playback and Video

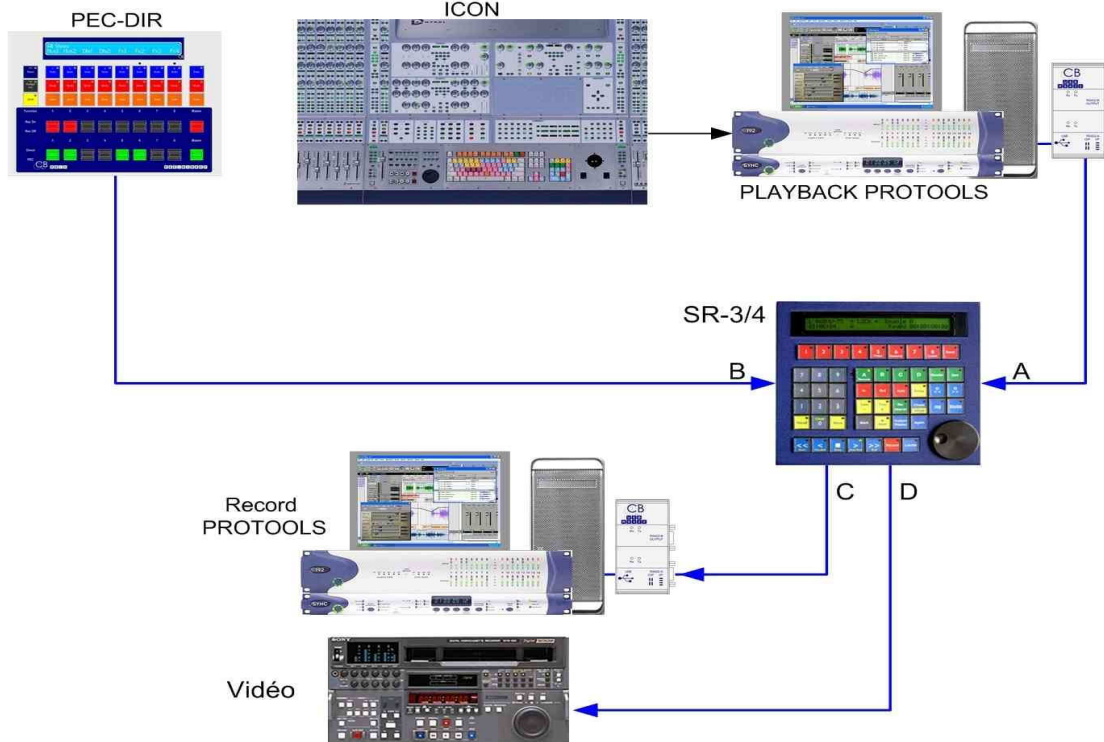

Pyramix Single Machine System: Internal Video

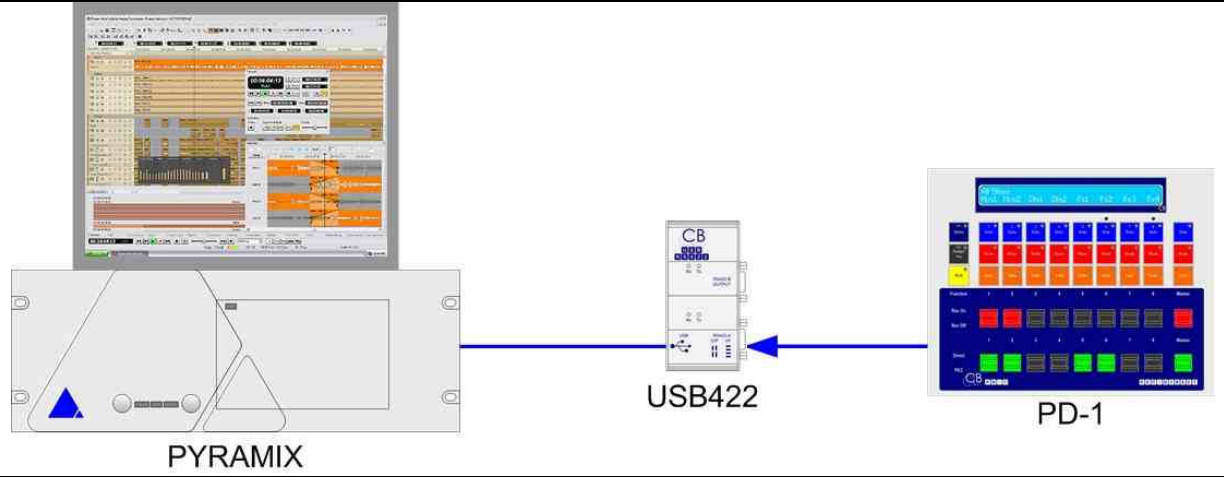

Pyramix Single Machine System: External Video

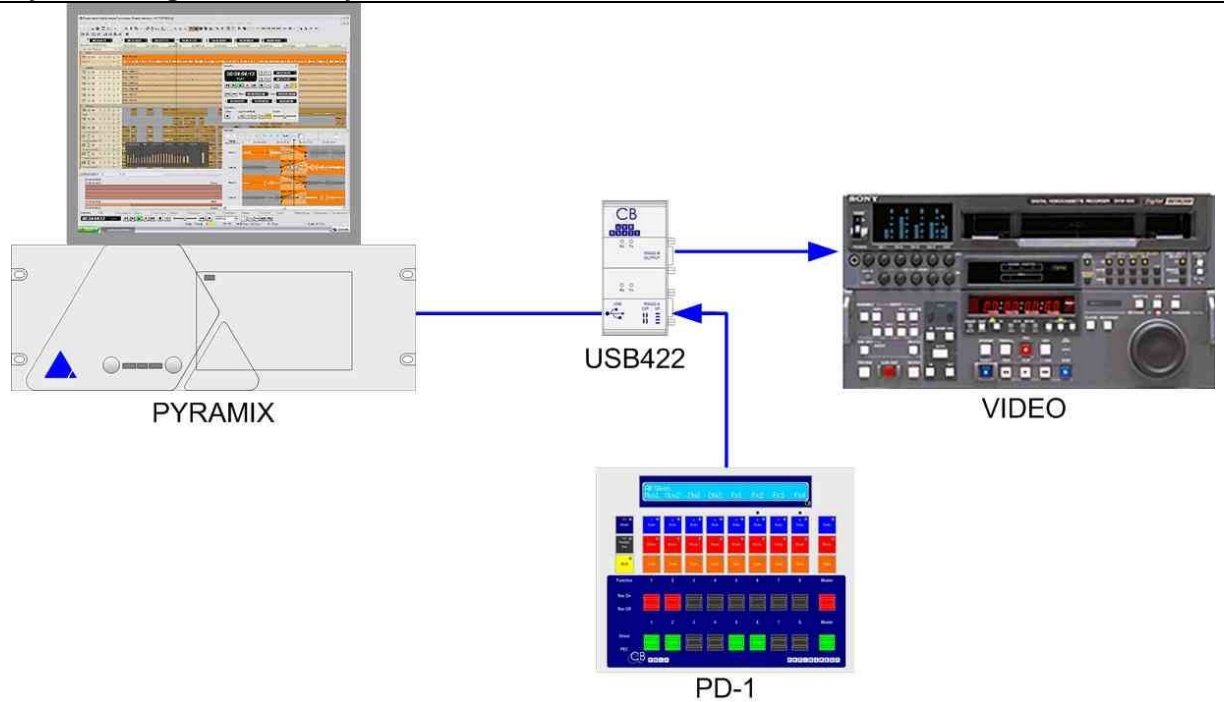

Pec - Direct Panel Operation

The panel is made up of 8 individual channels and a Master. The individual channels may be assigned to up to 64 individual tracks or one of 16 stems (Each stem can contain up to 8 tracks). The master may be assigned to any one of the sixteen Stems or one of the eight Global groups.

The sixteen stems may be defined with any combination of tracks up to a maximum of 8 tracks, the eight Global Groups may be defined with any combination of track and stems up to a maximum of 8. At Global group level the panel can control up to 64 tracks and at Stem level the panel can control up to 8 tracks.

Solo In Place

When Recording within the replay DAW special consideration must be given to solo, the Record (Stem) Solos must be separated from the replay solo's or solo in place will not work as expected. The PD-1 provides two menu options to facilitate this

1. Menu 10 : Solo using Mute
2. Menu 11: Internal solo safe

The actual set-up will depend on both the configuration and the workstation used, see the appendix for further information.

If Solo in Place is configured correctly, with the PD-1 is selected to Direct, Solo any playback channel and you will hear Solo In Place (The playback channel routed via the pan controls or panner, complete with any reverb or effect).

Display

Stem

Dlg1		ProT48			
00:00:00:00					
L	R	C	Sub	Sl	Sr

Top line: Current Stem Name, DAW Name, and DAW Position
Bottom line: Track assigned to each channel of the selected stem.

Global Group

Global 1	PMX-48	00:00:00:00
Dlg1	Fx1 Mus1 Aux1	

Top line: Global Group Number, DAW Name, and DAW position.
Bottom line: Stems/Tracks assigned to each channel

Full Track Name

In Stem mode the full name of the track assigned to a channel will be displayed for 5 seconds in the centre of the top line whenever a channel key is depressed.

Stem Name

In Global mode the name of the stem assigned to a channel will be displayed for 5 seconds in the centre of the top line whenever a channel key is depressed.

Keys

STEM

The Stem key is used to switch between Stem and global display modes.. To select a stem from a global display depress the [Stem] key, the LED will flash for approximately 3 seconds and **Select**

Stem' will be displayed. Whilst flashing, depressing any stem key will display the selected Stem.

Stem LED Off

Global Group mode: Stems are displayed and adjusted, if enabled (See Setup) individual channels may also be displayed. Use the [Assign] key with channel Solo or Mute keys to select Stems or channels.

Stem LED On

Stem Mode: Channels belonging to an individual stem are displayed and adjusted. Use the [Assign] key with channel Solo or Mute keys to select channels.

Stem LED Flashing

Select Stem Mode: Select a stem to expand and show channels by using a Solo key.

ASSIGN

Assign is used to select tracks to a stem, select tracks/stems to a group and select the current stem/group. To use depress and hold the Assign key, then use the mute and solo keys to select as follows.

The channel Solo key will increment the Selected Track or Stem Name assigned to its channel.
The channel Mute key will decrement the Selected Track or Stem Name assigned to its channel.

The Master Channel Solo Key will increment the Selected Stem/User Group for the Panel.
The Master Channel Mute Key will decrement the Selected Stem/User Group for the Panel.

Shift

The shift key is used with other keys

Holding Shift down will display 'Solo= SoloSafe and the solo keys should be used to setup solo safe.
Shift+Assign will enter Setup, Exit Setup from the root menu return to the root menu from a lower level.

The shift key also functions as a sticky key, the LED will stay illuminated for approximately 3 seconds and may be used in the following key combinations:-

Shift followed by Master Solo will clear all solos
Shift followed by Master Mute will clear all mutes
Shift followed by Master Safe will clear all safes

Channel SOLO

If assigned to a Track the channel solo will solo the selected track, The LED will illuminate when the track is soloed.

If assigned to a Stem the channel solo will solo all tracks in the selected Stem. The LED will illuminate when all of the tracks in the stem are soloed and flash if some but not all of the tracks are soloed.

Solo's are additive.

Channel MUTE

If assigned to a Track this key will mute the selected track, the LED will illuminate when the track is muted.

If assigned to a Stem the channel mute will mute all tracks in the selected Stem. The LED will illuminate if all of the tracks in the stem are muted and flash if some but not all of the tracks are muted.

The Mute LED's will not illuminate to indicate mute due to Solo.

Channel SAFE

If assigned to a Track the channel safe will safe the selected track. The LED will illuminate when the track is safe.

If assigned to a Stem the channel safe will safe all tracks in the selected Stem. The LED will illuminate when all of the tracks in the stem are safe and flash if some but not all of the tracks are safe.

As an alternative this key may be configured as a Ready key.

Channel record Paddle

Channel PEC-Direct Paddle

Master MUTE

The Master Mute will mute all tracks/Stems in the selected Stem/User Group. The LED will illuminate if any of the channels are muted.

Shift followed by Master Mute will clear all Mutes even those not defined by the panel.

Master SOLO

The Master Solo will Solo all tracks/Stems in the selected Stem/User Group. The LED will illuminate when any of the channels are in solo.

Shift followed by Master Solo will clear all Solos even those not defined by the panel.

Master Safe

The Master Safe will safe all tracks/Stems in the selected Stem/User Group. The LED will illuminate when any of the channels are safe.

Shift followed by Master Safe will send a Track Punch enable command to all DAW tracks that are NOT safe.

Master record Paddle

Master PEC-Direct Paddle

Solo-Safe

When the Shift key is held depressed and the message 'Solo= SoloSafe' is displayed in the user message display. In this mode the Solo keys are used to set/clear the Solo-Safe data. Menu 3 assigns the function of the Shift key. The Solo Safe function operates differently depending on the setting of Menu 13-Solo Command

1. **Use Mute:** No Solo Safe commands are sent to the DAW and the SoloSafe status is set and read internally. To enable solo in place, set all stem tracks to solosafe in the DAW. Note:
2. **Solo:** SoloSafe commands are sent to the DAW. The SoloSafe tallies are updated from the DAW.

UNIT SETUP

To enter set-up depress [Shift] and [Assign] simultaneously, after power on the Root Menu will always be displayed, subsequent entries into the set-up will return to the last accessed menu. To exit set-up depress [Shift] and [Assign] simultaneously.

Once in the Set-up Menu the solo keys numbered 1-8 are used to select parameter values, The [Stem ^] key is used to move up the menu tree, the [Assign v] key is used to move down the menu tree. The Root menu is at the top of the menu tree

The following parameters may be configured by the user.

Root Menu

Root 01:- Select Set-up Required
1= Unit 2= Serial-Out

1= Unit This selects parameters that control the operation of the unit
2= Serial-Out The Sony P2/Midi Output port and should be connected to the controlled device. urrently only Sony P2 is implemented.

Track/Stem Assign

Menu 02:- Track/Stem Assign
1= On 2= Locked 3= Auto-Stem

1. **On:** Holding the Assign key depressed the Mute and Solo keys may be used to select tracks and stems.
2. **Locked:** The Track and Stem assignment is locked. When the assign key is depressed a warning message is displayed. Note: The stem/group assign key still works.
3. **Auto-Stem:** The track names are read from the DAW, the Stem assignment is then set depending on the stem names provided that Menu03 Track and Stem Names are assigned to '3= S4T4' or '4= Stem Track'. Once finished track assignment is locked

Start from Track Number

Menu 03:- Start from Track Number
-1 +1 -10 +10 =01

This menu sets the starting track number for the PD-1, normally it will be set to Track 1

-1 The Solo-1 key will Decrement the Start Track Number
+1 The Solo-2 key will Increment the Start Track Number
-10 The Solo-3 key will subtract 10 from the Start Track Number
+10 The Solo-4 key will add 10 to the Start Track Number

Number of Tracks

Menu 04:- Number of Tracks
-1 +1 -10 +10 =24

This menu sets the starting track number for the PD-1, normally it will be set to Track 1

-1 The Solo-1 key will Decrement the Start Track Number
+1 The Solo-2 key will Increment the Start Track Number
-10 The Solo-3 key will subtract 10 from the Start Track Number
+10 The Solo-4 key will add 10 to the Start Track Number

Shift held Function

Menu 05:- Shift held Function
1= Off 2= Solo Safe 3= Print Master

This menu determines the function of the Solo keys and Leds when the Shift key is held depressed

- 1) **Off:** No function, Solo = Solo
- 2) **Solo Safe:** The Solo keys are used to enable/disable Solo-Safe.
- 3) **Print Master:** The Solo keys are used to enable/disable Print Master Tracks

Install Template

Menu 06:- Install Template
1= No Change 2= 24T Name 3= 24T Logical

This menu allows preset templates to be installed

1. No Change:
2. 24T Name: 24 Track, 4 Stems, Stem Name & Track Name Display
3. 24T Logical: 24 Track, 4 Stems, Stem Number & Track Number Display

Stem & Track display

Menu 07:- Stem & Track Display
1= Logical 2= Track 3= Track & Stem

The track names as Logical track numbers or read from the DAW.

1. **Logical:** Both Stem and Track names are logical
2. **Track:** The track name is read from DAW, the first 4 characters of the track name are displayed. Internal Stem names are used see Named Stems below.
3. **Track & Stem:** Both Track and stem names are read from the DAW, See menu 04 for the Track name format.

Logical Track names

Track 1..64 : Displayed as **Tk01..Tk64**

Logical Stem Names

Stem 1..16: Short Stem names **St01 ..St16**

Named Stems

Dialogue Stem: Displayed as **Dialogue 1 .. Dialogue 4** or **Dlg1.. Dlg4**

Music Stem: Displayed as **Music 1 .. Music 4** or **Mus1 .. Mus4**

Effects Stem: Displayed as **Effects 1 .. Effects 4** or **Fx-1 .. Fx-4**

Aux Stem: Displayed as **Aux Stem 1 .. Aux Stem 4** or **Aux1 .. Aux4**

Note 1 The Stem name read from the first named track in the stem.

Note 2 Only the first four characters of the Track Name will be displayed over the channel.

Stem & Track Name Format

Menu 08:- Stem & Track Name Format
1=Track 2=S2T 3=S3T 4=S4T 5=Stem Track

On DAW's which do not have separate Stem Names the Track name can be used for both the Stem

and Track name. This menu is used to decode the track name.

1. Track: Track Name only, no stem name
2. S2T: First 2 characters are the Stem Name, The following characters are the Track Name.
3. S3T: First 3 characters are the Stem Name, The following characters are the Track Name.
4. S4T: First 4 characters are the Stem Name, The following characters are the Track Name.
5. **Stem Track:** Stem and track are read from the DAW, Stem Name followed by Track name separated by a space, e.g. 'Music Left'. The short Stem and Track Names are displayed as the first four characters of each.

Note 1 The Stem name storage holds a maximum of 8 characters per stem.

Note 2 The Track name storage holds a maximum of 8 characters per track.

Note 2 The defined format is global and applies to all tracks.

Number of Global Groups

Menu 09- Number of Global Groups
1= 2= 3= 4= 5= 6= 7= 8=

Select the number of user groups to be used

Number of Stems

Menu 10- Number of Stems
1= 2 2=4 3=6 4=8 5=10 6=12 7=14 8=16

Select the number of stems to be used

User Group Contents

Menu 11- User Group Contents
1= Stems Only 2= Stems+Tracks

User Groups may be restricted to stems only or stems and tracks.

Record On/Off Keys

Menu 12:- Record Keys
1= Record 2= Arm Only 3= Arm & Stay

Record The Track arm keys send a Track Arm Command followed by Record On command
All arming removed when not in play.

Arm Only The Track arm keys send a track Arm Command Only.
All arming removed when not in play.

Arm & Stay In this mode the tracks are enabled using the channel keys and the **Master Record** key becomes a Master Record On/Record Off key.

Safe Pec/Dir Keys

Menu 13- Link Safe to Pec/Dir keys
1= On 2= Off

When On the Safe keys are linked to both the records and Pec/Direct keys inhibiting both Record and Direct selection.

Use Mute for Solo

Menu 14- Solo Cmd
1= Use Mute, 2= Solo

Solo may be implemented by using either the Solo or Mute command, select according to the DAW. One advantage of using Mutes for solos is that the Solo mute width is limited by the setting of the number of Tracks.

Record Safe Setting

Menu 15- Record Safe Setting
1= Internal 2= External

1. **Internal:** No commands are sent to the DAW and the Record Safe status is set and read internally.
2. **External:** record Safe commands are sent to the DAW. The Record Safe tallies are updated from the DAW.

After Auto Stem

Menu 16- After Auto-Stem
1= On 2=Lock

This menu determines the Track/Stem Assign Mode after Auto-Stem, see menu 02

Panel Type

Menu 17- Panel Type
1= Master 2=Slave

The PD-1 connected to the Workstation or CB Synchronizer is the master any PD-1 connected to another PD-1 should be set up as a Slave. The system will operate with all units set to Master but some operator interaction may occur if commands are simultaneous.

Test Display/Factory Setup

Menu 16- Test/Display
1= Position 2= Blank 3= Keys 4= Factory

Position	Display position information from controlled device
Blank	Position display
Keys	Display key numbers of depressed keys
Factory	Use with caution, this will reset the unit to its factory default condition! When Set exit from the setup menu will take about 4 seconds to write the factory data.

Factory Setup

Stem1 = Tracks1-8, Stem 2= Tracks 9-16, Stem3= Tracks 17-24, 24 Tracks, 4 Stems,
Global1 with Stems 1,2 & 3
Track Assign: 1= On
Stem & Track display: 1= Logical
Stem & Track Name Format: 1= Track
Number of Global Groups: 1=
Number of Stems: 2=4
Number of Tracks: 3=24

User Group Content: 1= Stems Only
Record Keys: 1= Record
Link safe to PEC/Dir keys: 1= On
Solo Cmd: 1= Use Mute
Solo Safe setting: 1= Internal
Record Safe Setting: 1= Internal
Panel Type: 1= Master
Test Display: 1= Position

Port B Menu

The Port B menu is used to define DAW specific parameters

Stem and Track Name Request

B:ProT24 19- Stem & Track Name Request
1= Combined 2= Separate

1. Combined: Default setting for ProTools
2. Separate Default setting for Pyramix

Position

B:ProT24 20- Position
1= LTC 2= VITC 3= L+V 4= Tim-1 5= L+V+T

Sony 9 pin allows for LTC, VITC and Timer 1 and Timer 2 position requests

Maximum Tracks per Command

B:ProT24 21- Maximum Tracks per Command
1= 48 2= 96

Protools can only accept 48 tracks per command

Track Arm Commands

B:ProT24 22- Track Arm Command
1= Extended 2= Normal

Use Extended Track Arm commands when connected to Protools or Pyramix, use Normal Track Arm commands when connected to recorders that do not understand the extended protocol.

Note: Only the extended protocol allows control of Solo, Mute, Pec/Direct, Safe

Protocol

B:ProT24 19- Protocol
1= Sony P2 2= MMC

Select the Protocol, Currently only Sony P2 is supported

Reading Stem and Track Names

To read and display the track and stem names correctly the PD-1 must be set correctly, after a

Factory Reset (Unit | Test/Display 4=Factory) the following menu options must be set:

Unit | Track Assign: This must be set to 1= On in order to read the track names, or 4=Auto-Stem to read track names and build stems

Unit | Stem & Track Display: This must be set to Track or Track & Stem dependant on your track naming convention.

Unit | Stem & Track Name Format: Set according to your stem/track naming convention, we recommend 5= Stem Track.

Serial-out | Stem & Track Name Request: This is DAW dependent and should be set as follows

1=Combined for ProTools

2= Separate for Pyramix

With the latest software this is automatic provided that the device name is set correctly in the DAW.

Auto-Stem

In Order for the auto-stem logic to work correctly the stem and track names should read correctly and the unit set as detailed above. Then select 4= Auto-stem in the Track Assign Menu, leave setup and the rest is Magic! If you are having problems the email us a text file with a list of the track names, the setup that you are using, and the date of the software and we will try and help.

Rear Panel Connections

Serial In

RS422 input to the PD-1, used when daisy chaining multiple units, or to save/recall track assignments from an external computer. A special converter card is available to connect power to the PD-1 via this input. Use the CB Electronics USB-422 (USB to RS422) or similar when connected to a windows pc to upload new firmware, or save/recall PD-1 configurations using the support software.

Serial Out

RS422 output from the PD-1 should be connected to the machine emulation input of the DAW, or when multiple PD-1's are used to the Input of the next PD-1.

Used with a UR-MIDI converter and with the Output (Port-B) protocol selected to MIDI can be used to control a DAW using MMC (Not yet Implemented).

+5v

Connect to the supplied 5v Power supply, the centre pin is positive.

Software Updates

May be downloaded from our website and installed by the user. For details go to the customer area on our website, <http://www.colinbroad.com/cbsoft/pdSoft.html> and download the install program and updates.

Appendix

Using the PD-1 with a Pro Tools

The PD-1 may be used on Pro Tools version 7.2 and later. See separate document "pd1template.pdf" for full details.

Connect the output of the PD-1 to Pro Tools via the CB Electronics USB-422 (A suitable Driver will be required) or similar device. Configure Port-A on the USB-422 as the Remote input to Pro Tools and enable. A standard Sony 9 pin cable may then be used to connect the Output of the PD-1 to port A on the USB-422.

Pro Tools set-up : Single Pro Tools

- 1) Build multi-channel tracks (5.1...7.1) for each stem so that the pan will operate correctly
- 2) Pro-Tools Preference >Synchronisation > Allow Tracks Arm Commands in Local Mode.
- 3) Route the multi-channel track outputs to individual mono tracks for recording
- 4) Mix the stem outputs to a composite stem
- 5) Root the composite stem outputs to your monitoring system
- 6) Enable solo safe on the multi-track stem, the individual record stems and the composite stems
- 7) Connect the PD-1 and set for Solo via mute and internal solo safe.
- 8) On the PD-1 enable solo safe the composite stem.
- 9) Solo safe any effect send and returns (For example reverb)

Pro Tools set-up: Separate Record Pro Tools

- 1) Route the track inputs from the stems to individual tracks to record
- 2) Mix the stem outputs to a composite stem
- 3) Root the composite stem outputs to your monitoring system
- 4) Enable solo safe on the composite stems
- 5) Connect the PD-1 and select Solo using Mute or Solo.
- 6) On the PD-1 enable solo safe the composite stem.
- 7) On your playback system Solo safe any effect send and returns (For example reverb)

The suggested ProTools signal path below may be used with or without a separate record ProTools. The PD-1 controls the record and monitor on the stems and on the final mix (comp). Care should be taken over the track names so that they can be recognised in the first four characters. For instance two stems 'Music1' and 'Music2' will both show as 'Musi', use 'Mus1' and 'Mus2' or equivalent.

Suggested ProTools Signal Path

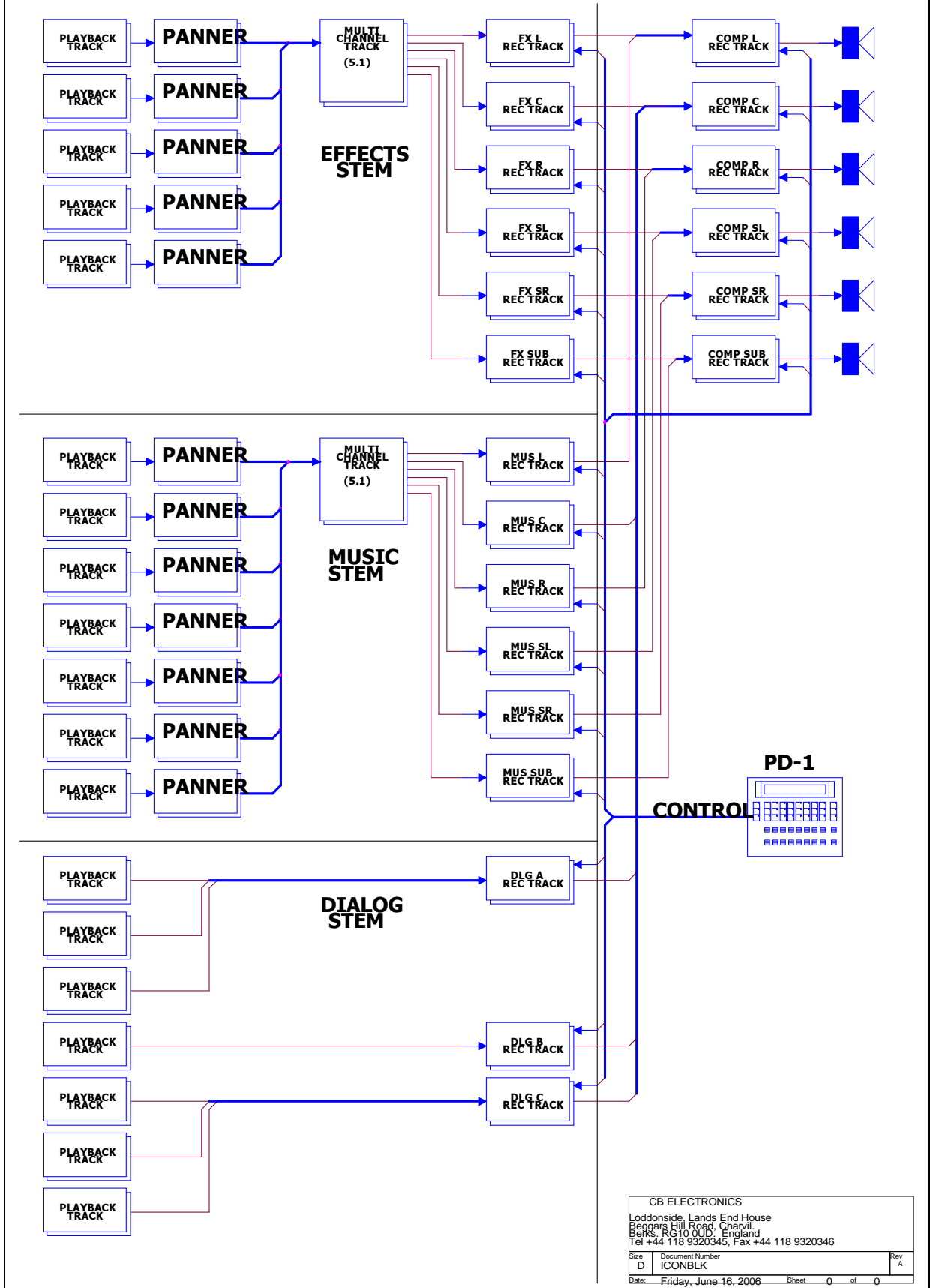

CB ELECTRONICS
 Loddonside, Lands End House
 Beggars Hill Road, Charvil,
 Berks, RG10 0UD, England
 Tel +44 118 9320345, Fax +44 118 9320346

Size	Document Number	Rev
D	ICONBLK	A
Date	Friday, June 16, 2006	Sheet 0 of 0

Using the PD-1 with Pyramix

The PD-1 may be used on Pyramix version 5.XX.XSP2 and later.

Connect the output of the PD-1 to Pyramix via the CB Electronics USB-422 (A suitable Driver will be required) or similar device. Configure Port-A on the USB-422 as the Remote input to Pyramix and enable. A standard Sony 9 pin cable may then be used to connect the Output of the PD-1 to port A on the USB-422.

PD-1 Master/Slave Setting

On the PD-1 connected to the RM-6 , SR-3, or DAW Menu 15-Panel Type must be set to 1= Master

Using the PD-1 with the UR-422

Connect the selected UR422 output port to the PD-1 Input, Connect the PD-1 Output to the DAW in the same way as described above.

Using the PD-1 with the SR-4 or RM-6

Connect the PD-1 Output to the selected SR-4/RM-6 input, Connect the selected SR-4/RM-6 output to the DAW in the same way as described above.

On the SR-4/RM-6 select the DAW, Record Enable the DAW Port and make the following setups

Setup | Iface | Record | Menu 42- Record Tracks

Match the number of tracks on the PD-1 this will improve the name update speed.

Setup | Ext | Menu 106- DAW Port for PD-1

Select the port to which the DAW is connected.

Setup | Ext | Menu 099- External Machine ID

This menu determines the ID of the controlled machine and the Name displayed in the PD-1

Setup | Unit | Generic | Menu 032- Input Ports

Select as required to suit the number input ports used.

Note 1: The PD-1 must be connected to an input port.

Note 2: SR-4 Track arming will not operate on the SR-4 when directed to the machine assigned to the PD-1.

SR-4, PD-1 Connections

Port A: Normal or Tx-Rx Invert, dependant on internal Links

Ports B, C: Tx-Rx Invert cable

RM-6, PD-1 Connections

Port F: Normal

Port E: Normal or Tx-Rx Invert, dependant on internal links

Port D, C, B: Tx-Rx Invert cable

CB Electronics

Loddonside, Lands End House, Beggars Hill Road, Charvil, Berkshire, RG10 0UD, UK

Tel +44 (0) 1189 320345 Fax +44 (0) 1189 320346

<http://www.colinbroad.com> E-mail Support@colinbroad.com